



INSTALLATION INSTRUCTIONS

Accessory

REAR BUMPER APPLIQUE
P/N 08P48-TZ5-200

Application

2015 MDX

Publications No.

BII 51635

Issue Date

MAY 2014

PARTS LIST

Rear bumper applique

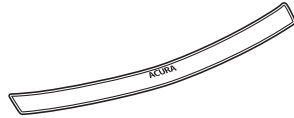

Applicator

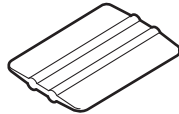

Soft sleeve

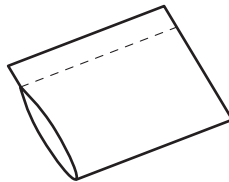

TOOLS AND SUPPLIES REQUIRED

Isopropyl alcohol

Shop towel

Masking tape

Spray bottle

3M Protective tape application solution

INSTALLATION

NOTE:

- Do not damage the body paint finish.
 - This rear bumper applique should be installed only if the ambient air temperature is 15°C (60°F) or above.
 - To allow the adhesive to cure, do not wash the vehicle for 24 hours. Please advise the client.
1. Open the tailgate. Using isopropyl alcohol on a shop towel, clean the rear bumper where the rear bumper applique will attach.

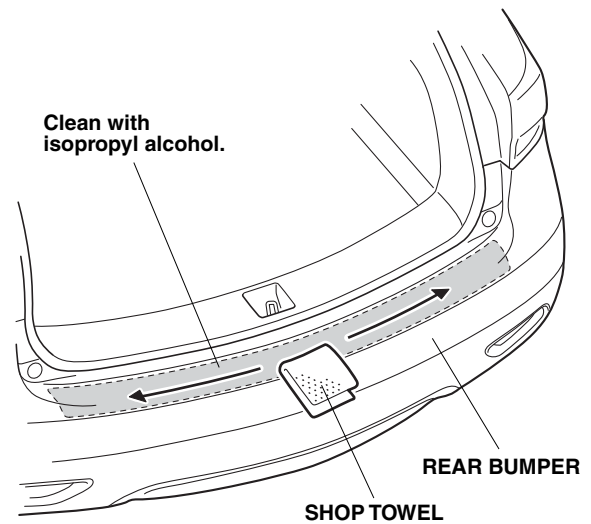

QBN1220AH

- Place the rear bumper applique on the rear bumper and check the rear bumper applique attaching position.

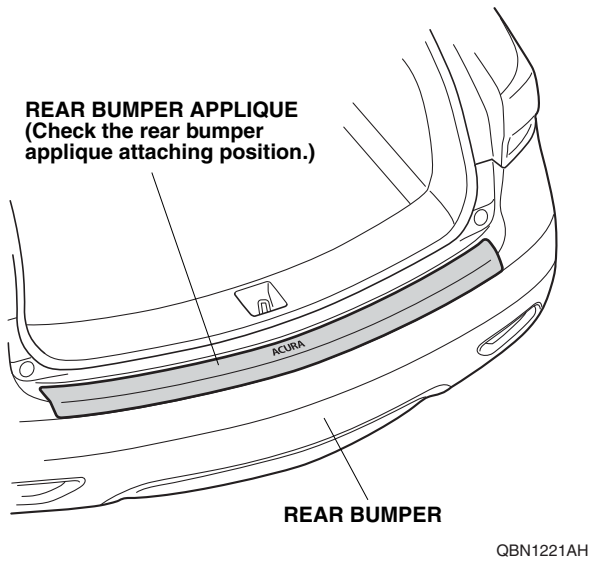

- Remove the rear bumper applique.
- Using a spray bottle with 3M protective tape application solution, spray the area where the rear bumper applique will attach.

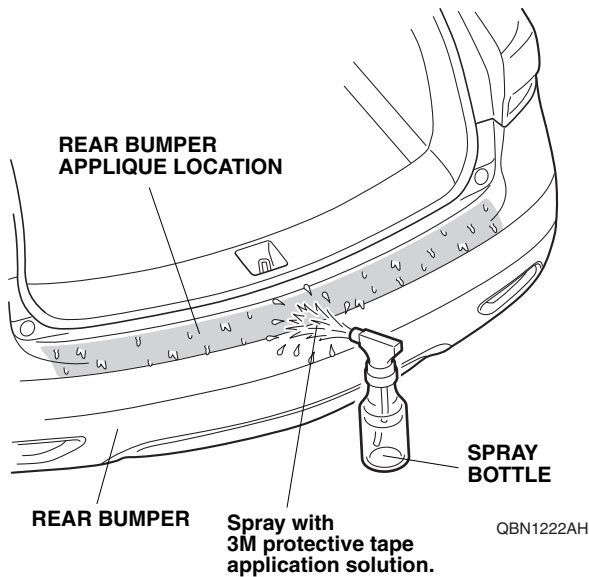

- Remove the adhesive backing from the rear bumper applique.

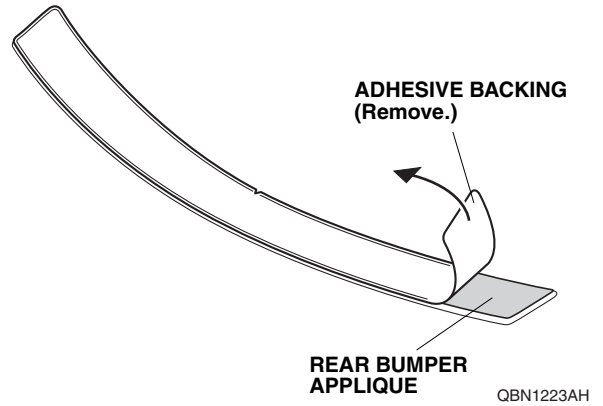

- Using a spray bottle with 3M protective tape application solution, spray the rear bumper applique.

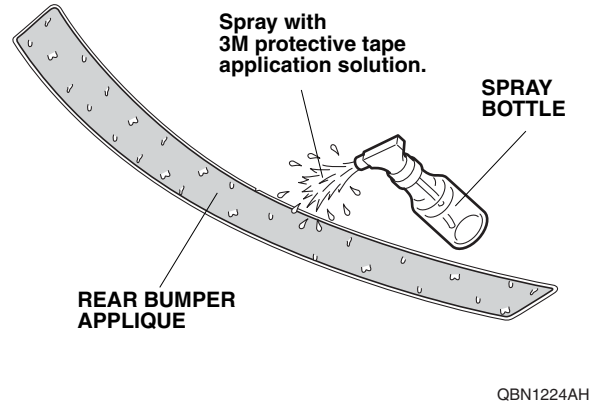

- Align the V-notch on the rear bumper applique with the center of the tailgate striker as shown. Smooth rear bumper applique against the rear bumper and tape each end at the curved surface.

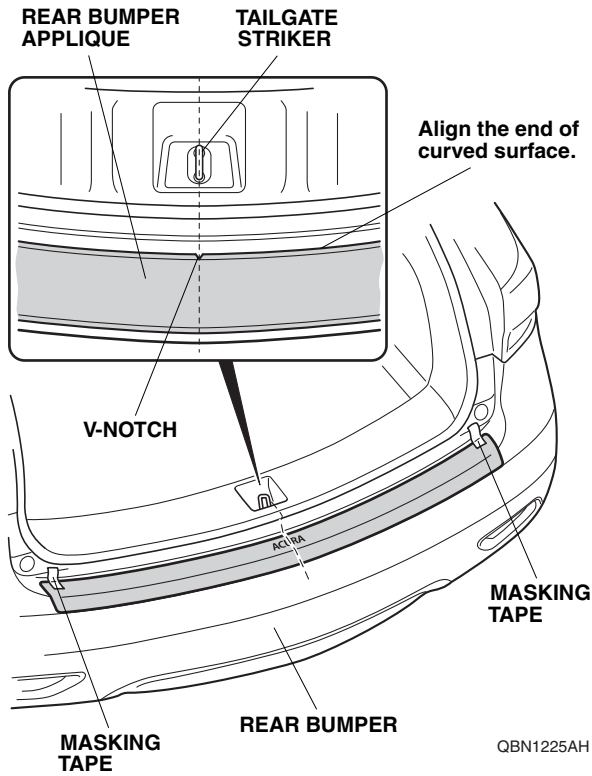

- Insert the applicator into the soft sleeve.

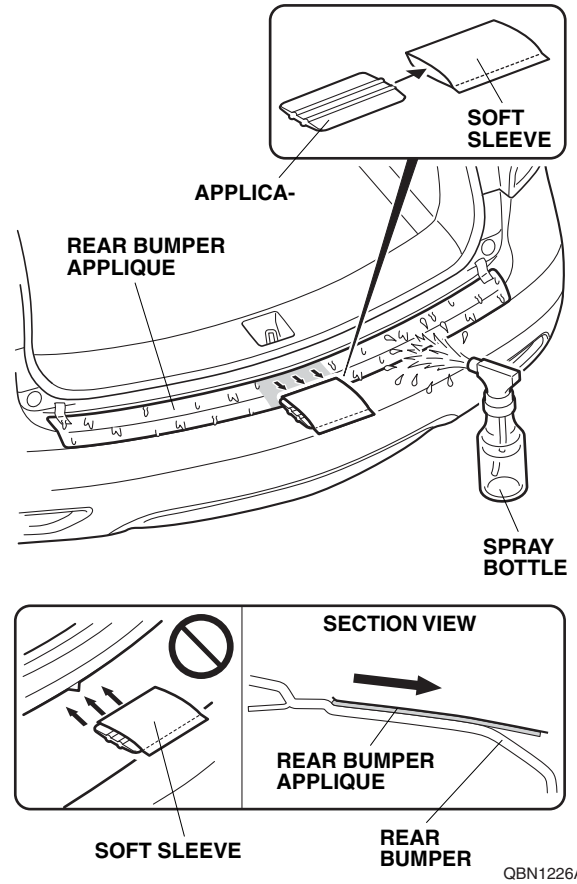

- Using a spray bottle with 3M protective tape application solution, spray the top of the rear bumper applique.
- Using the soft sleeve, apply pressure to smooth out the top surface at the center of the rear bumper applique using downward strokes. Move the soft sleeve in one direction only.

- Starting from the center and working outward, use the soft sleeve to smooth the rear bumper applique. Stroke in one direction with quick motion. If you see an air bubble, stop and gently peel up that section to work out the bubble. Work slowly and keep pressure against the rear bumper applique.

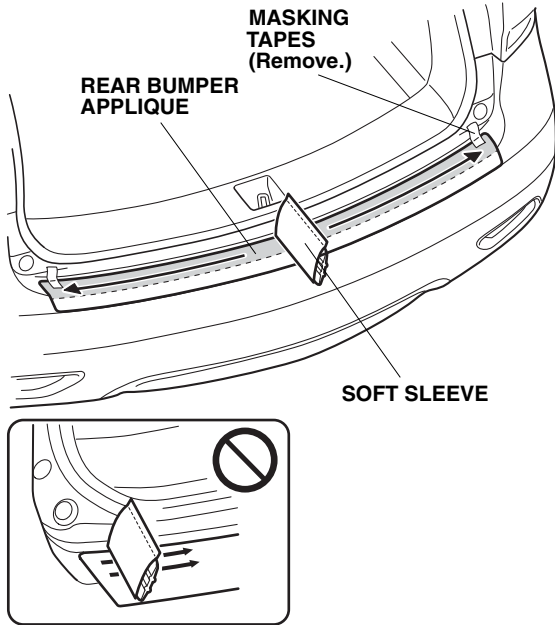

QBN1227AH

- Remove the masking tapes attached in step 7.

- Remove the protective film from the top of the rear bumper applique. Remove the protective film by pulling it slowly and horizontally. Do not peel up the protective film.

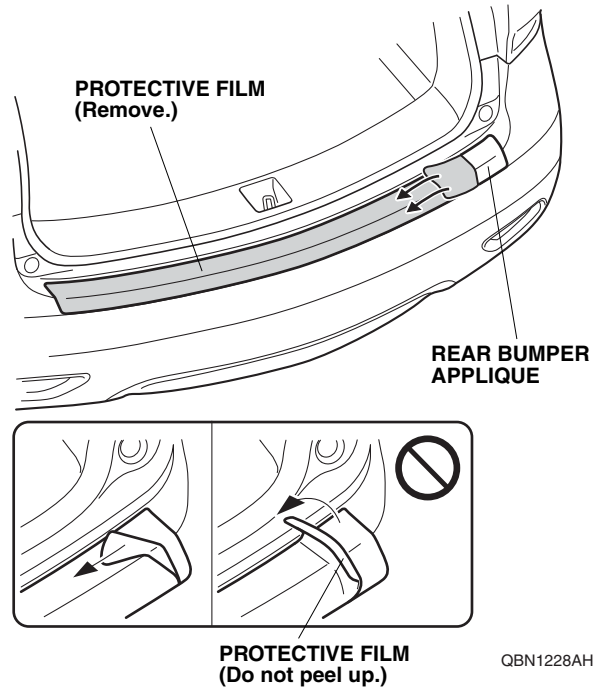

QBN1228AH

- Once the flat surface is completely smooth with no bubbles, use the soft sleeve to apply the rear bumper applique to the rounded rear edge at the center as shown.

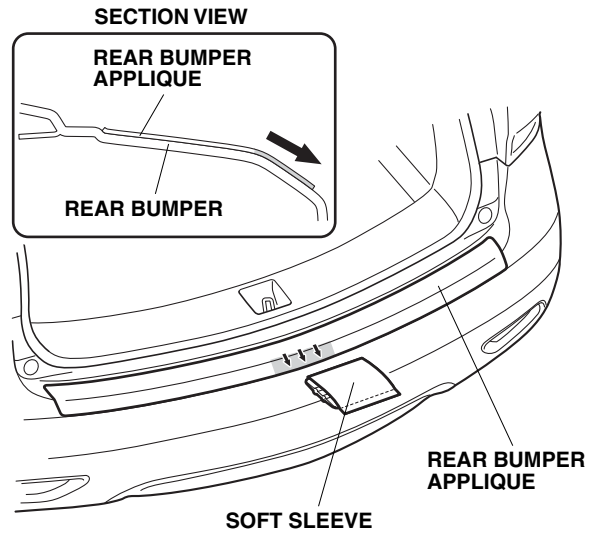

QBN1229AH

15. Use the soft sleeve to apply the rear bumper applique to the rounded rear edge on the left side as shown. Start in the center and work outward. Repeat for the right side.

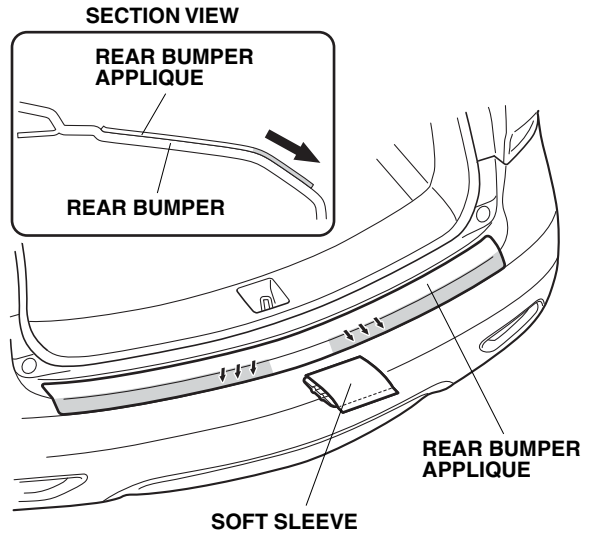

QBN1230AH

16. Using a shop towel, wipe the excess 3M protective tape application solution. Allow the rear bumper applique to dry thoroughly.

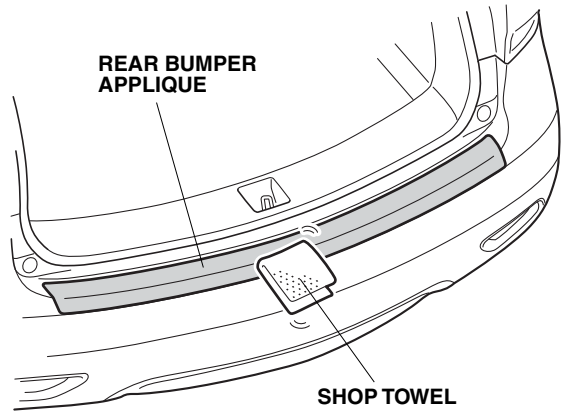

QBN1231AH